



SNS COLLEGE OF TECHNOLOGY
Coimbatore-35
An Autonomous Institution



Accredited by NBA – AICTE and Accredited by NAAC – UGC with 'A++' Grade
Approved by AICTE, New Delhi & Affiliated to Anna University, Chennai

DEPARTMENT OF ELECTRONICS & COMMUNICATION ENGINEERING

19ECT301- COMMUNICATION NETWORKS

III YEAR/ V SEMESTER

UNIT 2 –DATA-LINK LAYER & NETWORK LAYER

TOPIC 2– DLC SERVICES, DATA LINK LAYER PROTOCOLS



Link layer



our goals:

- ❖ understand principles behind **link layer services**:
 - error detection, correction
 - sharing a broadcast channel: **multiple access**
 - **link layer addressing**
 - local area networks: **Ethernet**, VLANs
- ❖ instantiation, implementation of various link layer technologies



Link layer, LANs: outline



- ❖ introduction, services
- ❖ error detection, correction
- ❖ multiple access protocols
- ❖ LANs
 - addressing, ARP
 - Ethernet
 - switches
 - VLANS



Link layer: Introduction



terminology:

- ❖ hosts and routers: **nodes**
- ❖ communication channels that connect adjacent nodes along communication path: **links**
 - **wired links**
 - **wireless links**
 - LANs
- ❖ layer-2 packet: **frame**, encapsulates datagram

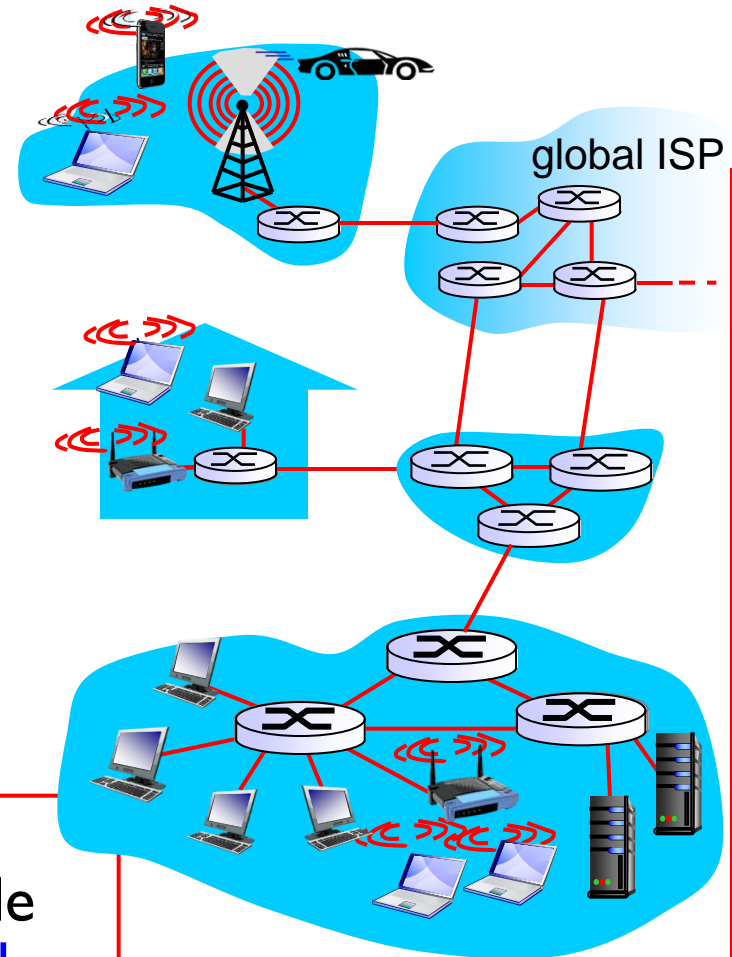

data-link layer has responsibility of transferring datagram from one node to *physically adjacent* node **over a link**



Link layer: context



datagram transferred by different link protocols over different links:

- e.g., **Ethernet** on first link, **frame relay** on intermediate links, **802.11** on last link

Each link protocol provides different services

- e.g., may or may not provide rdt over link

transportation analogy:

- ❖ trip from Princeton to Lausanne
 - **limo**: Princeton to JFK
 - **plane**: JFK to Geneva
 - **train**: Geneva to Lausanne
- ❖ tourist = **datagram**
- ❖ transport segment = **communication link**
- ❖ **transportation mode** = **link layer protocol**
- ❖ travel agent = **routing algorithm**



Link layer services



❖ *framing, link access:*

- encapsulate datagram into frame, adding header, trailer
- channel access if shared medium
- “MAC” addresses used in frame headers to identify source, dest
 - different from IP address!

❖ *reliable delivery between adjacent nodes*

- we learned how to do this already (chapter 3)!
- seldom used on low bit-error link (fiber, some twisted pair)
- wireless links: high error rates
 - Q: why both link-level and end-end reliability?
 - A: correcting errors *locally*, rather than end-end



Link layer services (contd.)



❖ *flow control:*

- pacing between adjacent sending and receiving nodes

❖ *error detection:*

- errors caused by signal attenuation, noise.
- receiver detects presence of errors:
 - signals sender for retransmission or drops frame

❖ *error correction:*

- receiver identifies *and corrects* bit error(s) without resorting to retransmission

❖ *half-duplex and full-duplex*

- with half duplex, nodes at both ends of link can transmit, but not at same time



Where is the link layer implemented?



- ❖ in each and every **host**
- ❖ link layer implemented in “adaptor” (aka **network interface card** NIC) or on a chip
 - Ethernet card, 802.11 card; Ethernet chipset
 - implements link, physical layer
- ❖ attaches into host's system buses
- ❖ combination of hardware, software, firmware

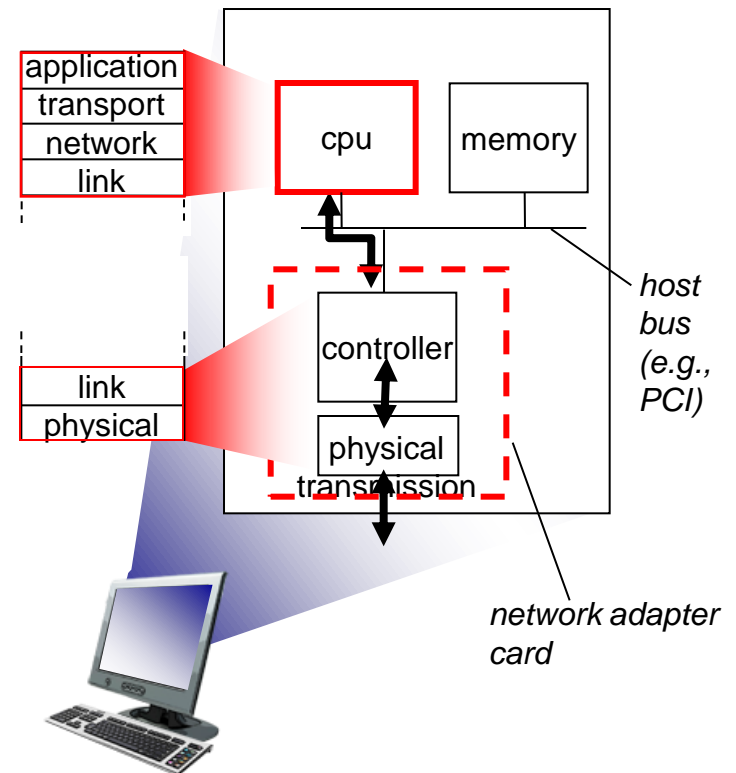



Adaptors communicating

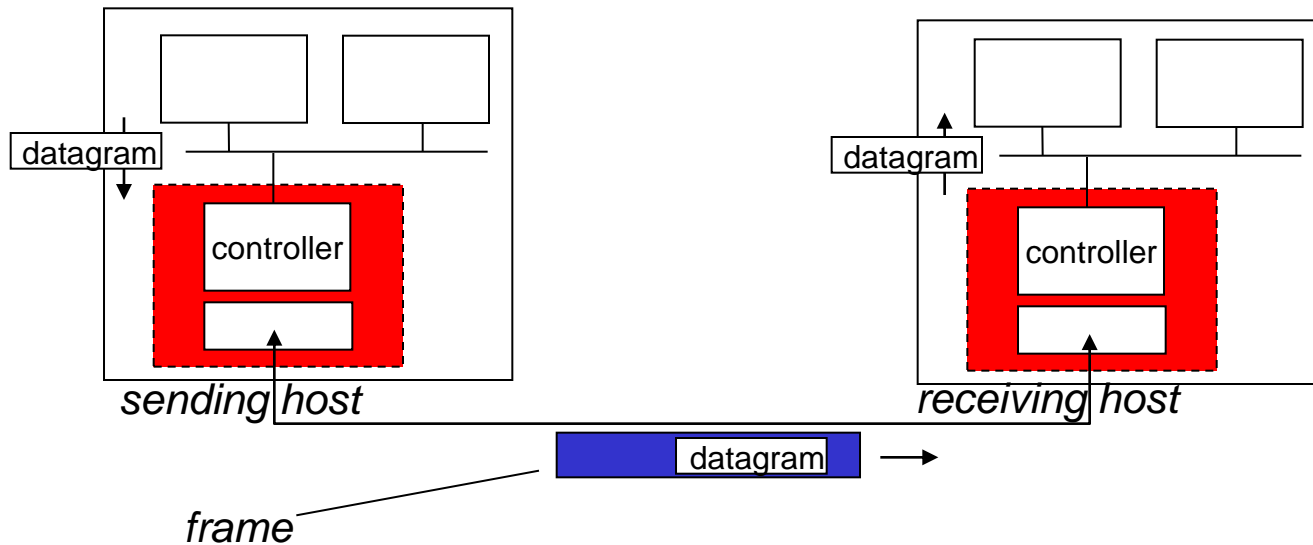

❖ sending side:

- encapsulates datagram in frame
- adds error checking bits, rdt, flow control, etc.

❖ receiving side

- looks for errors, rdt, flow control, etc
- extracts datagram, passes to upper layer at receiving side



Link layer, LANs: outline



- ❖ introduction, services
- ❖ error detection, correction
- ❖ multiple access protocols
- ❖ LANs
 - addressing, ARP
 - Ethernet
 - switches
 - VLANS



Error detection



EDC= Error Detection and Correction bits (redundancy)

D = Data protected by error checking, may include header fields

- Error detection not 100% reliable!
 - protocol may miss some errors, but rarely
 - larger EDC field yields better detection and correction

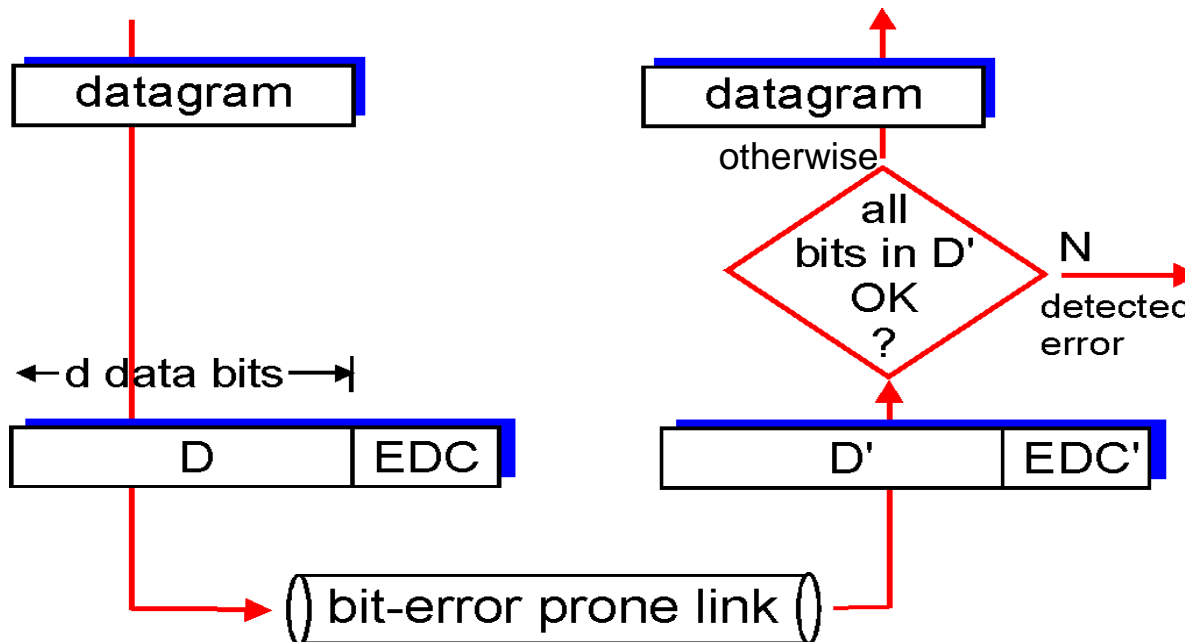



Parity checking



single bit parity:

- ❖ detect single bit errors

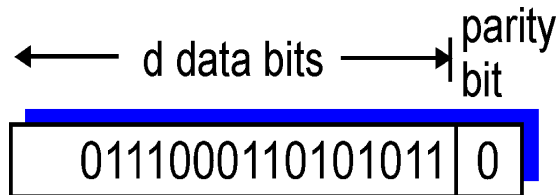

two-dimensional bit parity:

- ❖ detect and correct single bit errors

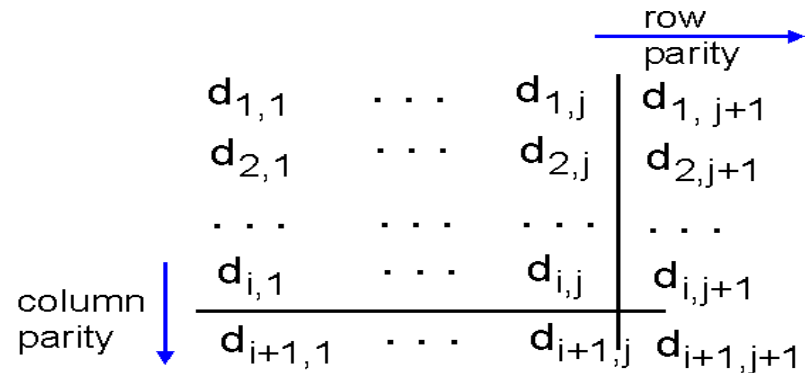

1	0	1	0	1	1	
1	1	1	1	0	0	
0	1	1	1	0	1	
1	0	1	0	1	0	
0						

no errors

1	0	1	0	1	1	
1	0	1	1	0	0	
0	1	1	1	0	1	
1	0	1	0	1	0	
0						

parity error
correctable single bit error



Internet checksum (review)



goal: detect “errors” (e.g., flipped bits) in transmitted packet
(note: used at transport layer *only*)

sender:

- ❖ treat segment contents as **sequence of 16-bit integers**
- ❖ checksum: addition (**1's complement sum**) of segment contents
- ❖ sender puts checksum value into UDP checksum field

receiver:

- ❖ compute checksum of received segment
- ❖ **check if computed checksum equals checksum field value:**
 - **NO** - error detected
 - **YES** - no error detected.
But maybe errors nonetheless?



Cyclic redundancy check



- ❖ more powerful error-detection coding
- ❖ view data bits, **D**, as a binary number
- ❖ choose $r+1$ bit pattern (**generator**), **G**
- ❖ goal: choose r CRC bits, **R**, such that
 - $\langle D, R \rangle$ exactly divisible by **G** (modulo 2)
 - receiver knows **G**, divides $\langle D, R \rangle$ by **G**. **If non-zero remainder: error detected!**
 - can detect all burst errors less than $r+1$ bits
- ❖ widely used in practice (Ethernet, 802.11 WiFi, ATM)

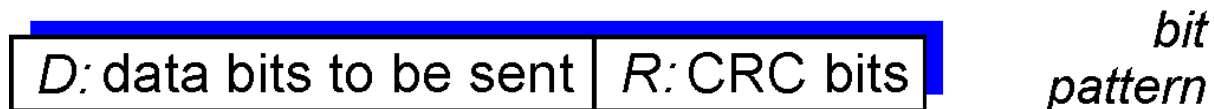
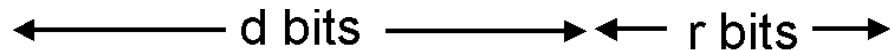

$$D * 2^r \text{ XOR } R$$

mathematical formula



CRC example



want:

$$D \cdot 2^r \text{ XOR } R = nG$$

equivalently:

$$D \cdot 2^r = nG \text{ XOR } R$$

equivalently:

if we divide $D \cdot 2^r$ by G , want remainder R to satisfy:

$$R = \text{remainder} \left[\frac{D \cdot 2^r}{G} \right]$$

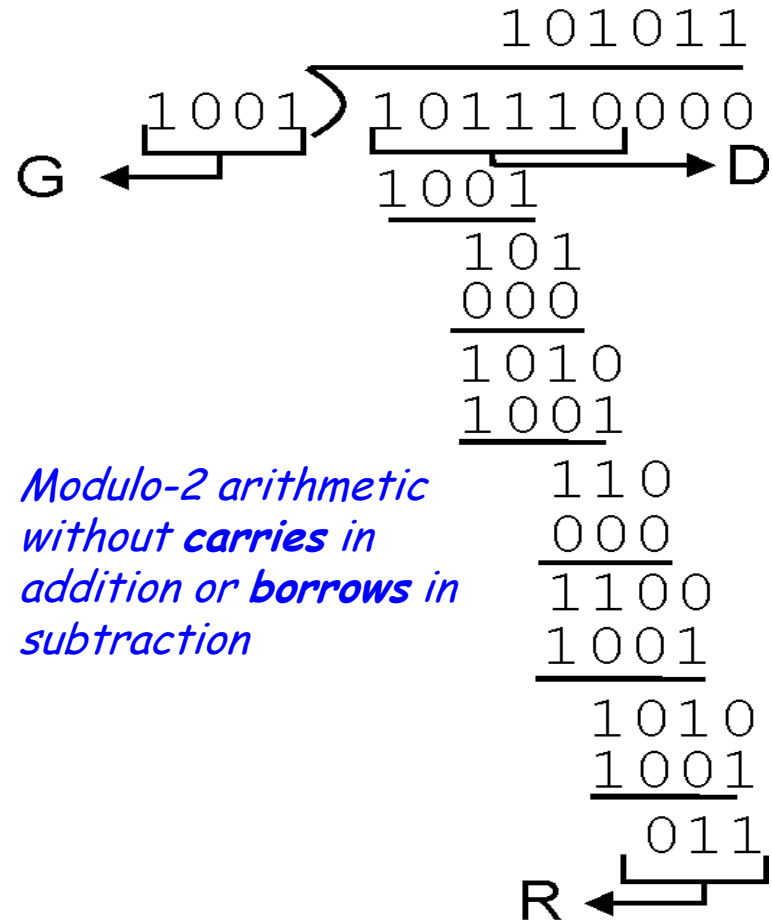



Link layer, LANs: outline



- ❖ introduction, services
- ❖ error detection, correction
- ❖ **multiple access protocols**
- ❖ LANs
 - addressing, ARP
 - Ethernet
 - switches
 - VLANS



Multiple access links, protocols



two types of “links”:

❖ point-to-point

- PPP for dial-up access
- point-to-point link between Ethernet switch, host

❖ *broadcast (shared wire or medium)*

- old-fashioned Ethernet
- upstream HFC
- 802.11 wireless LAN



shared wire (e.g.,
cabled Ethernet)



shared RF
(e.g., 802.11 WiFi)

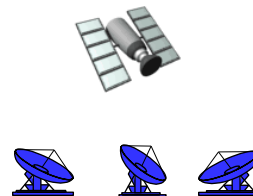

shared RF
(satellite)



humans at a
cocktail party
(shared air, acoustical)



Multiple access protocols



- ❖ single shared broadcast channel
- ❖ two or more **simultaneous transmissions** by nodes:
interference
 - **collision** if node receives two or more signals at the same time

multiple access protocol

- ❖ distributed algorithm that **determines how nodes share channel**, i.e., determine when node can transmit
- ❖ **communication about channel sharing must use channel itself!**
 - no out-of-band channel for coordination



An ideal multiple access protocol



Given: broadcast channel of rate R bps

Desired data:

1. when one node wants to transmit, it can send at rate R .
2. when M nodes want to transmit, each can send at average rate R/M
3. **fully decentralized:**
 - no special node to coordinate transmissions
 - no synchronization of clocks, slots
4. **Simple**

MAC: Media Access Control



MAC protocols: taxonomy



three broad classes:

❖ *channel partitioning*

- divide channel into smaller “pieces” (time slots, frequency, code)
- allocate piece to node for exclusive use

❖ *random access*

- channel not divided, allow collisions
- “recover” from collisions

❖ *“taking turns”*

- nodes take turns, but nodes with more to send can take longer turns



TDMA: time division multiple access

- ❖ access to channel in "rounds"
- ❖ each station gets fixed length slot (length = pkt trans time) in each round
- ❖ unused slots go idle
- ❖ example: 6-station LAN, 1,3,4 have pkt, slots 2,5,6 idle

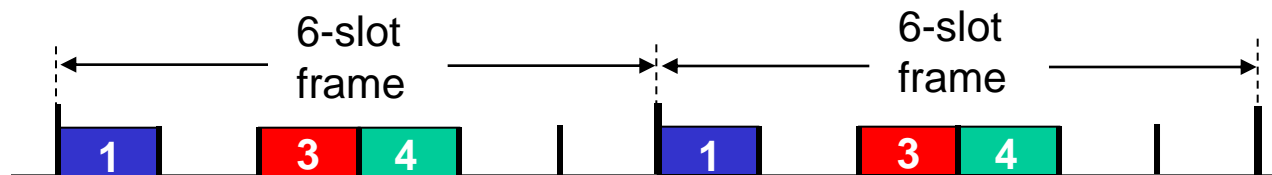



Channel partitioning MAC protocols: FDMA



FDMA: frequency division multiple access

- ❖ channel spectrum divided into frequency bands
- ❖ each station assigned fixed frequency band
- ❖ unused transmission time in frequency bands go idle
- ❖ example: 6-station LAN, 1,3,4 have pkt, frequency bands 2,5,6 idle

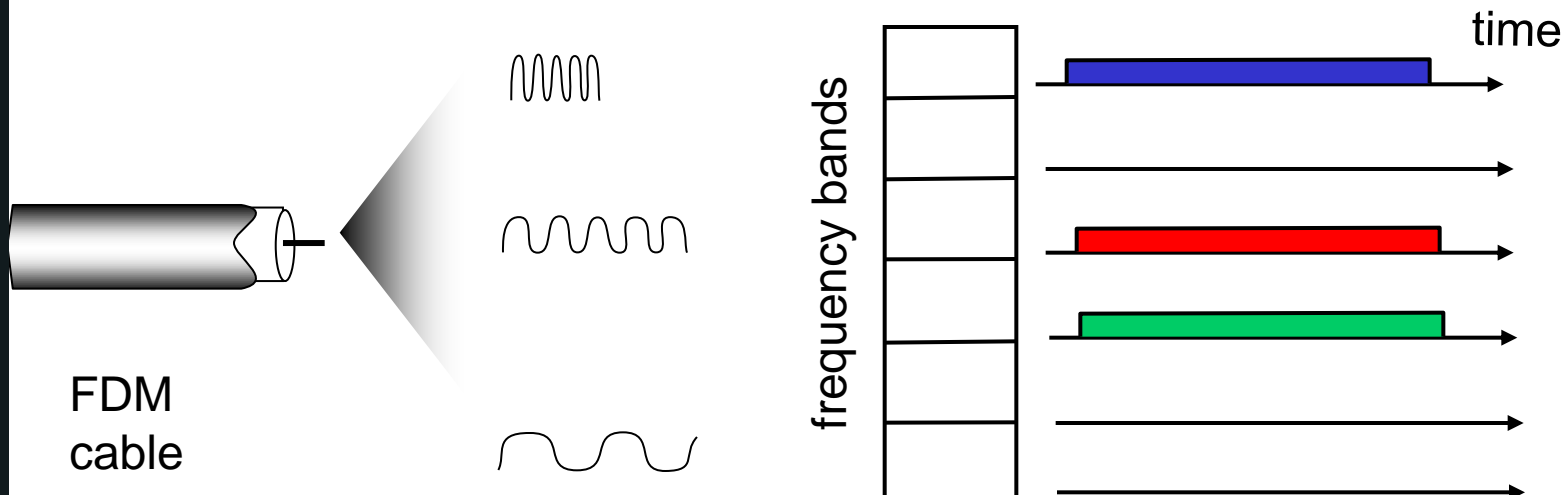



Random access protocols



- ❖ when node has packet to send
 - transmit at full channel data rate R .
 - *no a priori coordination* among nodes
- ❖ two or more transmitting nodes → “collision”,
- ❖ **random access MAC protocol** specifies:
 - how to **detect** collisions
 - how to **recover** from collisions (e.g., via delayed retransmissions)
- ❖ examples of random access MAC protocols:
 - slotted ALOHA
 - ALOHA
 - CSMA, CSMA/CD, CSMA/CA



Slotted ALOHA



assumptions:

- ❖ all frames same size
- ❖ time divided into equal size slots (**time to transmit 1 frame**)
- ❖ nodes start to transmit only **slot beginning**
- ❖ **nodes are synchronized**
- ❖ if 2 or more nodes transmit in slot, all nodes detect collision

operation:

- ❖ when node obtains fresh frame, transmits in next slot
 - *if no collision*: node can send new frame in next slot
 - *if collision*: node retransmits frame in each subsequent slot **with prob. p** until success



Slotted ALOHA

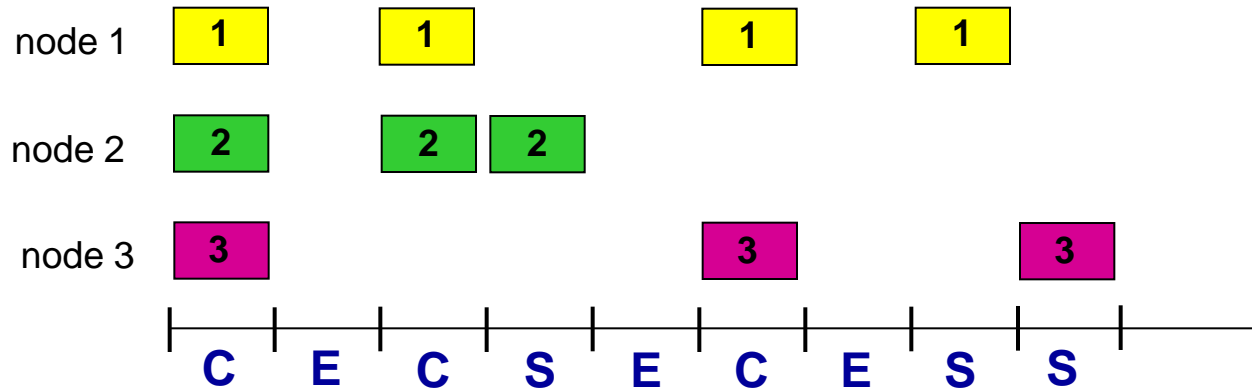

Pros:

- ❖ **single active** node can continuously transmit at full rate of channel
- ❖ **highly decentralized**: only slots in nodes need to be in sync
- ❖ simple

Cons:

- ❖ collisions, wasting slots
- ❖ idle slots
- ❖ nodes may be able to detect collision in less than time to transmit packet
- ❖ clock synchronization



Slotted ALOHA: efficiency



efficiency: long-run fraction of successful slots (many nodes, all with many frames to send)

- ❖ suppose: N nodes with many frames to send, each transmits in slot with probability p
- ❖ prob that given node has success in a slot = $p(1-p)^{N-1}$
- ❖ prob that *any* node has a success = $Np(1-p)^{N-1}$

- ❖ max efficiency: find p^* that maximizes $Np(1-p)^{N-1}$
- ❖ for many nodes, take limit of $Np^*(1-p^*)^{N-1}$ as N goes to infinity, gives:

$$\text{max efficiency} = 1/e = .37$$

at best: channel used for useful transmissions 37% of time!





Pure (unslotted) ALOHA

- ❖ unslotted Aloha: simpler, **no synchronization**
- ❖ when frame first arrives
 - transmit immediately
- ❖ collision probability increases:
 - frame sent at t_0 collides with other frames sent in $[t_0 - 1, t_0 + 1]$

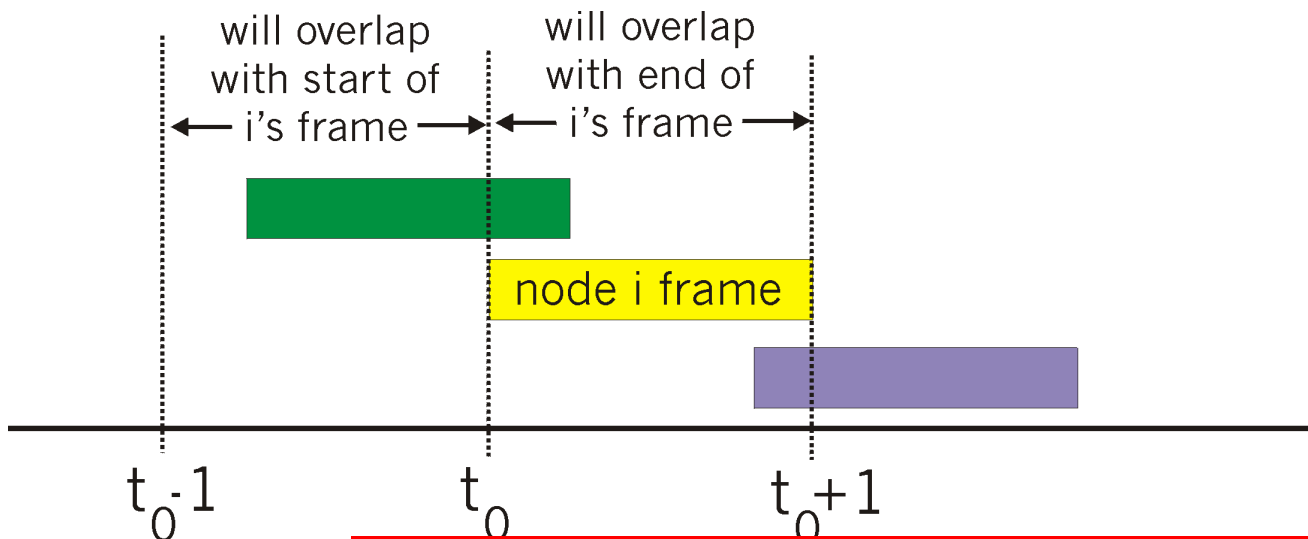



Pure ALOHA efficiency



$P(\text{success by given node}) = P(\text{node transmits}) \cdot$

$P(\text{no other node transmits in } [t_0-1, t_0]) \cdot$

$P(\text{no other node transmits in } [t_0-1, t_0])$

$$= p \cdot (1-p)^{N-1} \cdot (1-p)^{N-1}$$

$$= p \cdot (1-p)^{2(N-1)}$$

... choosing optimum p and then letting $n \rightarrow \infty$

$$= 1/(2e) = .18$$

even worse than slotted Aloha!



CSMA (carrier sense multiple access)



CSMA: listen before transmit:

if channel sensed idle: transmit entire frame

❖ if channel sensed busy, defer transmission

❖ human analogy: don't interrupt others!



CSMA collisions

spatial layout of nodes



- ❖ collisions *can* still occur: propagation delay means two nodes may not hear each other's transmission
- ❖ collision: entire packet transmission time wasted
 - distance & propagation delay play role in determining collision probability





CSMA/CD (collision detection)



CSMA/CD: carrier sensing, deferral as in CSMA

- collisions *detected* within short time
 - colliding transmissions *aborted*, reducing channel wastage
- ❖ collision detection:
- *easy in wired LANs*: measure signal strengths, compare transmitted, received signals
 - *difficult in wireless LANs*: received signal strength overwhelmed by local transmission strength
- ❖ human analogy: the polite conversationalist



CSMA/CD (collision detection)

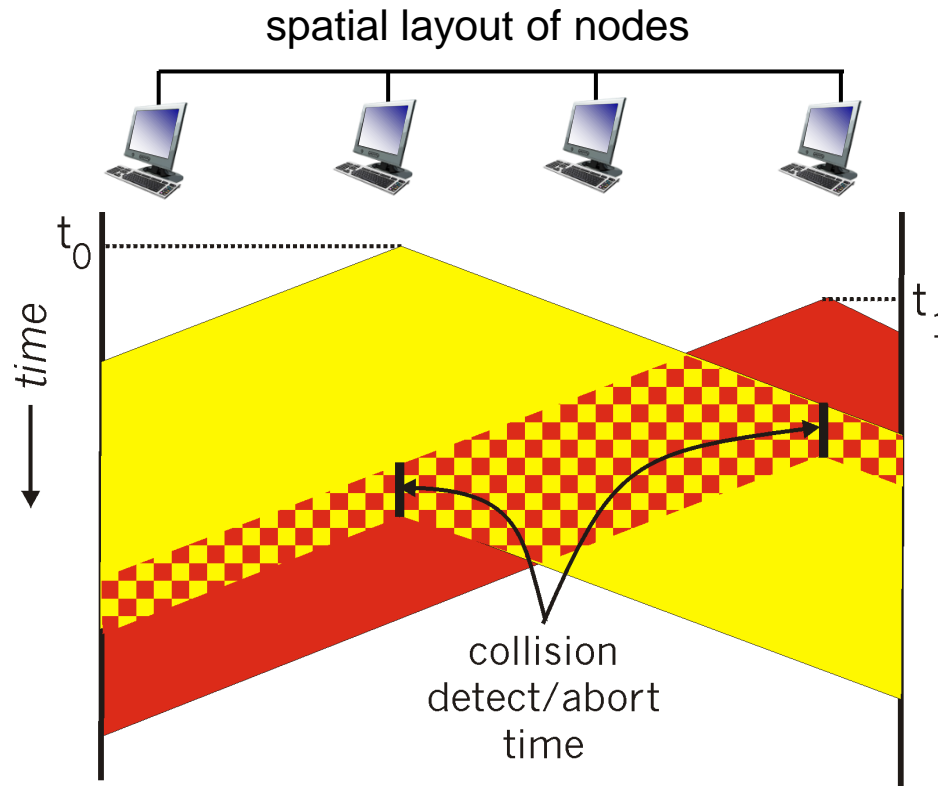



Ethernet CSMA/CD algorithm



1. NIC receives datagram from network layer, creates frame
2. If NIC senses channel idle, starts frame transmission. If NIC senses channel busy, waits until channel idle, then transmits.
3. If NIC transmits entire frame without detecting another transmission, NIC is done with frame !
4. If NIC detects another transmission while transmitting, aborts and sends jam signal
5. After aborting, NIC enters *binary (exponential) backoff*:
 - after m^{th} collision, NIC chooses K at random from $\{0, 1, 2, \dots, 2^m - 1\}$. NIC waits $K \cdot 512$ bit times, returns to Step 2
 - longer backoff interval with more collisions



CSMA/CD efficiency



- ❖ T_{prop} = max prop delay between 2 nodes in LAN
- ❖ t_{trans} = time to transmit max-size frame

$$efficiency = \frac{1}{1 + 5t_{prop}/t_{trans}}$$

- ❖ efficiency goes to 1
 - as t_{prop} goes to 0
 - as t_{trans} goes to infinity
- ❖ better performance than ALOHA: and simple, cheap, decentralized!



“Taking turns” MAC protocols



channel partitioning MAC protocols:

- share channel *efficiently* and *fairly* at high load
- inefficient at low load: delay in channel access, 1/N bandwidth allocated even if only 1 active node!

random access MAC protocols

- efficient at low load: single node can fully utilize channel
- high load: collision overhead

“taking turns” protocols

look for best of both worlds!



“Taking turns” MAC protocols



polling:

- ❖ master node “invites” slave nodes to transmit in turn
- ❖ typically used with “dumb” slave devices
- ❖ concerns:
 - polling overhead
 - latency
 - single point of failure (master)

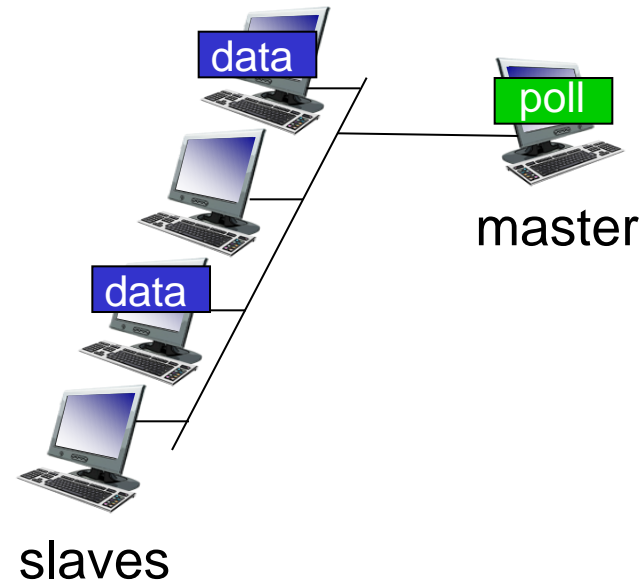



“Taking turns” MAC protocols



token passing:

- ❖ control *token* passed from one node to next sequentially.
- ❖ token message
- ❖ concerns:
 - token overhead
 - latency
 - single point of failure (token)

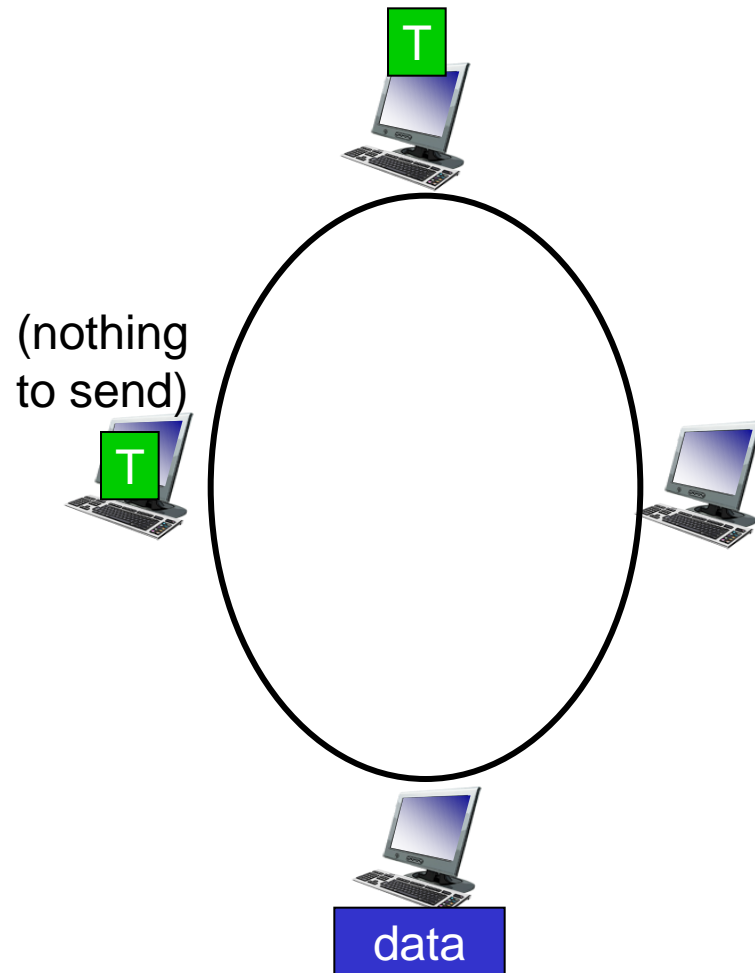



Cable access network



Internet frames, TV channels, control transmitted downstream at different frequencies

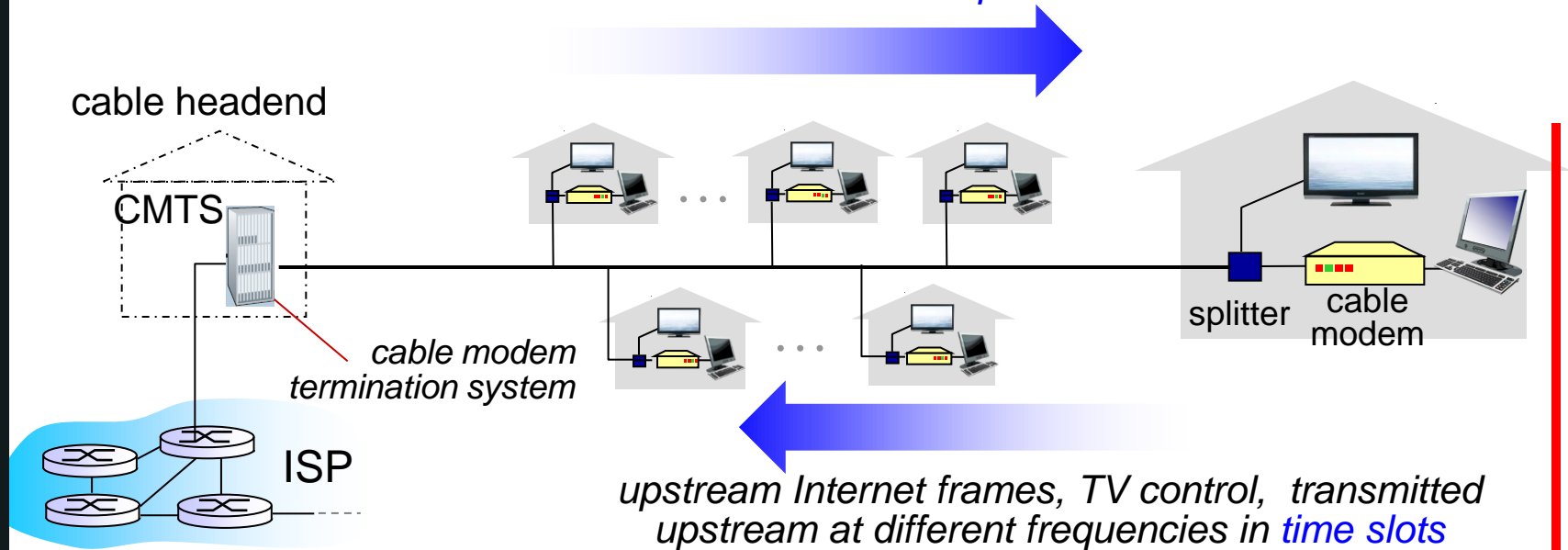

- ❖ **multiple** 40Mbps **downstream** (broadcast) channels
 - single CMTS transmits into channels
- ❖ **multiple** 30 Mbps **upstream** channels
 - **multiple access**: all users contend for certain upstream channel time slots (others assigned)



Cable access network

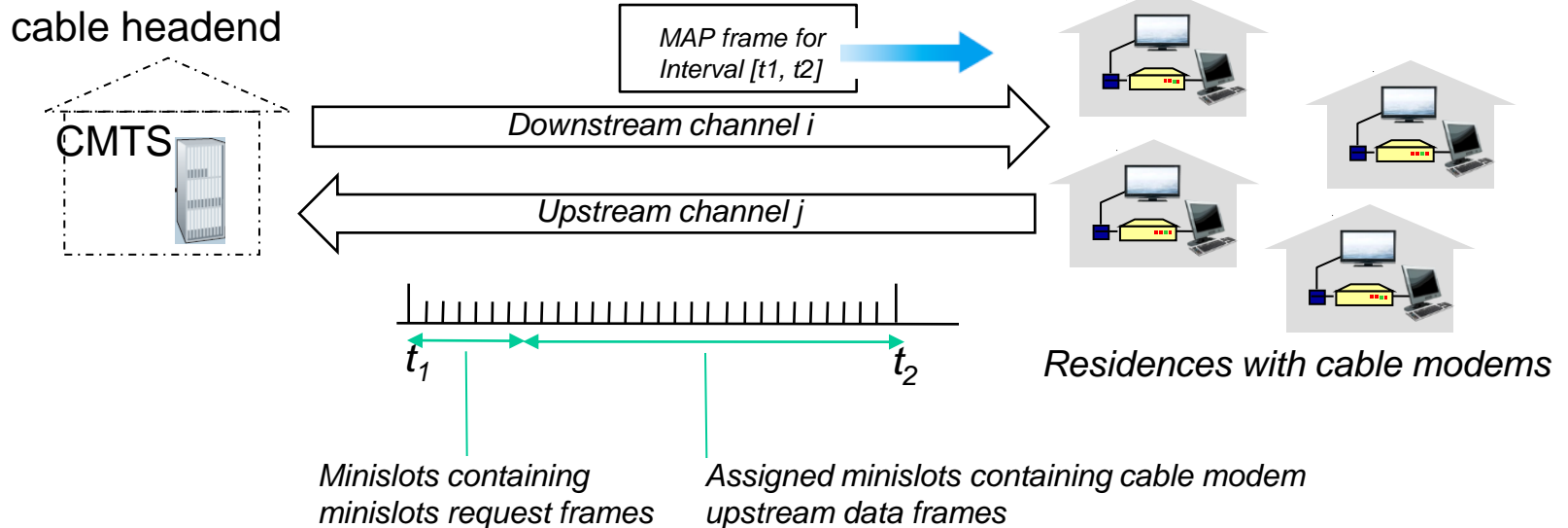

DOCSIS: data over cable service interface spec

- ❖ FDM over upstream, downstream frequency channels
- ❖ TDM upstream: some slots assigned, some have contention
 - downstream **MAP (bandwidth allocation map) frame**: assigns upstream slots
 - request for upstream slots (and data) transmitted random access (binary backoff) in selected slots



Summary of MAC protocols



- ❖ *channel partitioning*, by time, frequency or code
 - Time Division, Frequency Division
- ❖ *random access* (dynamic),
 - ALOHA, S-ALOHA, CSMA, CSMA/CD
 - carrier sensing: easy in some technologies (wire), hard in others (wireless)
 - CSMA/CD used in Ethernet
 - CSMA/CA used in 802.11 (Collision Avoidance)
- ❖ *taking turns*
 - polling from central site, token passing
 - bluetooth, FDDI, token ring



THANK YOU