



# **SNS COLLEGE OF TECHNOLOGY**

**(An Autonomous Institution)**



**COIMBATORE-35**

**Accredited by NBA-AICTE and Accredited by NAAC – UGC with A+ Grade**

**Approved by AICTE, New Delhi & Affiliated to Anna University, Chennai**

**DEPARTMENT OF ELECTRICAL AND ELECTRONICS ENGINEERING**

**COURSE NAME: 23EET203 Electrical Machines I**

**II YEAR / III SEMESTER**

**Unit 1 – DC Generator**

**Topic 5: Characteristics of DC generator**





# What We'll Discuss

## TOPIC OUTLINE



A Case  
Characteristics of DC Generator  
Practical Implementation  
Assessment



# A CASE

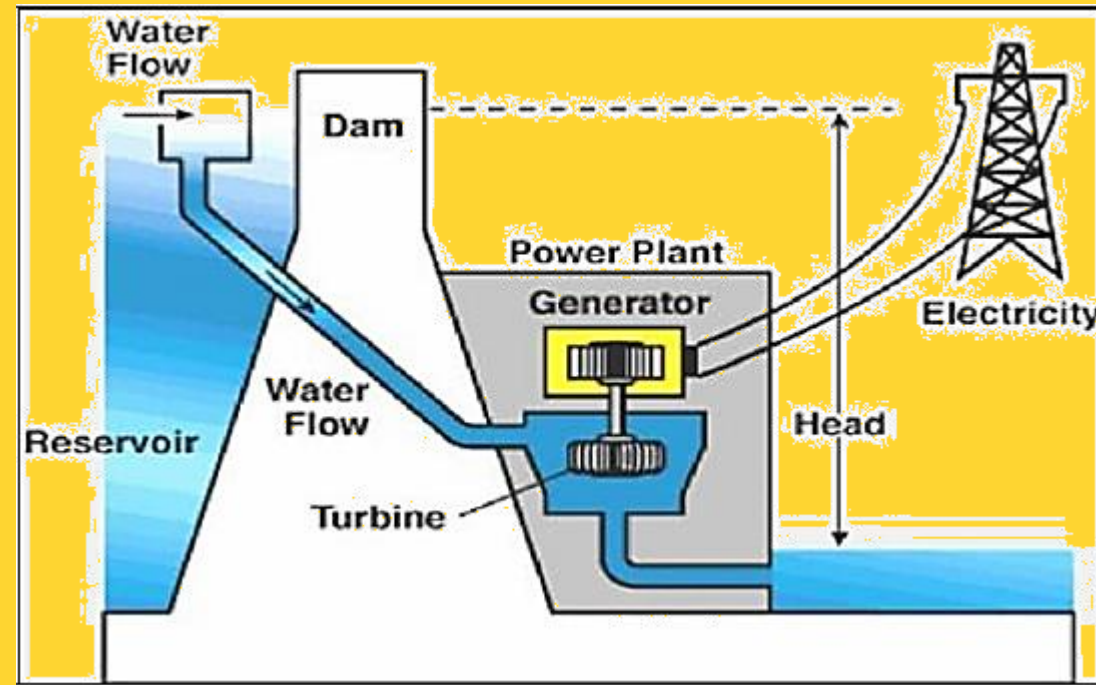

- Identify the types of Generating stations
- Different types of generators are used in different places, why?



# Characteristics – DC Generator

The following are the three most important characteristics in a D.C. generator:

1. Open Circuit Characteristics ( $E_o/I_F$ )
2. Internal Characteristics ( $E/I_a$ )
3. External Characteristics ( $V/I_a$ )



# Critical Resistance for shunt Generator



- The value of resistance of shunt field winding beyond which the self generator fails to build up its voltage is known as "critical resistance" at a given speed it is the maximum field resistance with which the shunt generator excite.
- Shunt generator will build up voltage only if field circuit resistance is less than critical field resistance.

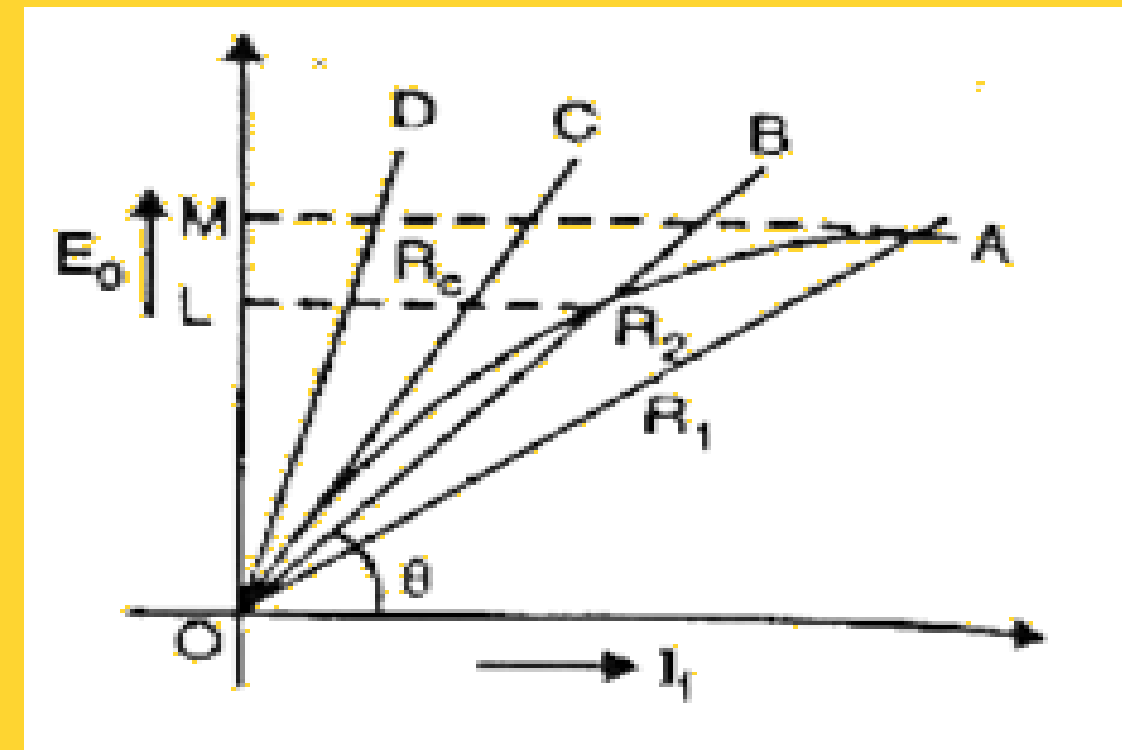
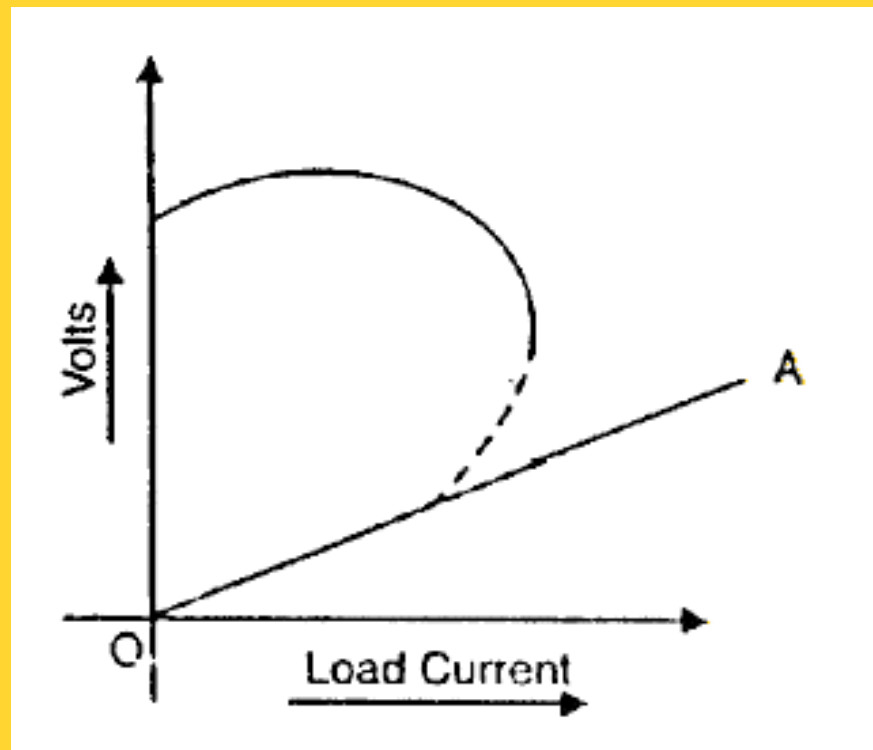



# O.C.C. at Different Speeds

- If we are given O.C.C. of a generator at a constant speed  $N_1$  then we can easily draw the O.C.C. at any other constant speed  $N_2$ .
- Here we are given O.C.C. at a constant speed  $N_1$ .
- It is desired to find the O.C.C. at constant speed  $N_2$  (it is assumed that  $n_1 < N_2$ ) For constant excitation,  $E \propto N$ .
- $E_2/E_1 = N_2/N_1$

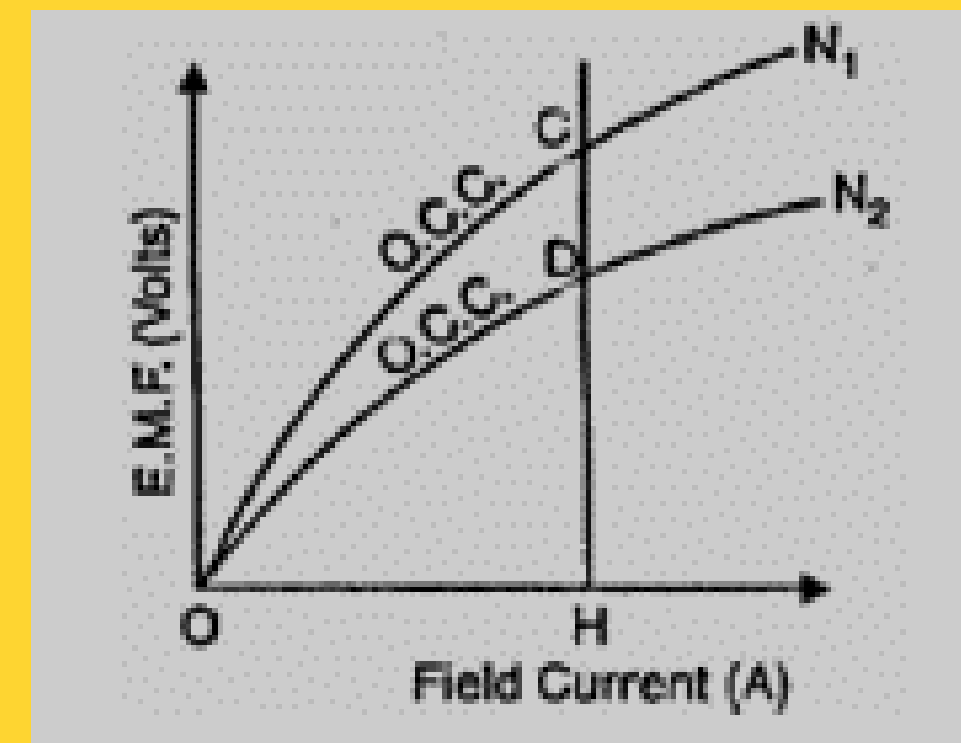



# Critical Speed (NC)



The critical speed of a shunt generator is the minimum speed below which it fails to excite.



Therefore , **Speed  $\propto$  Critical resistance**

In order to find critical speed, take any convenient point C on excitation axis and erect a perpendicular so as to cut  $R_{sh}$  and  $R'_{sh}$  lines at points B and A respectively. Then,

$$BC/AC = N_C/N$$
$$\text{or } N_C = N \times (BC/AC)$$

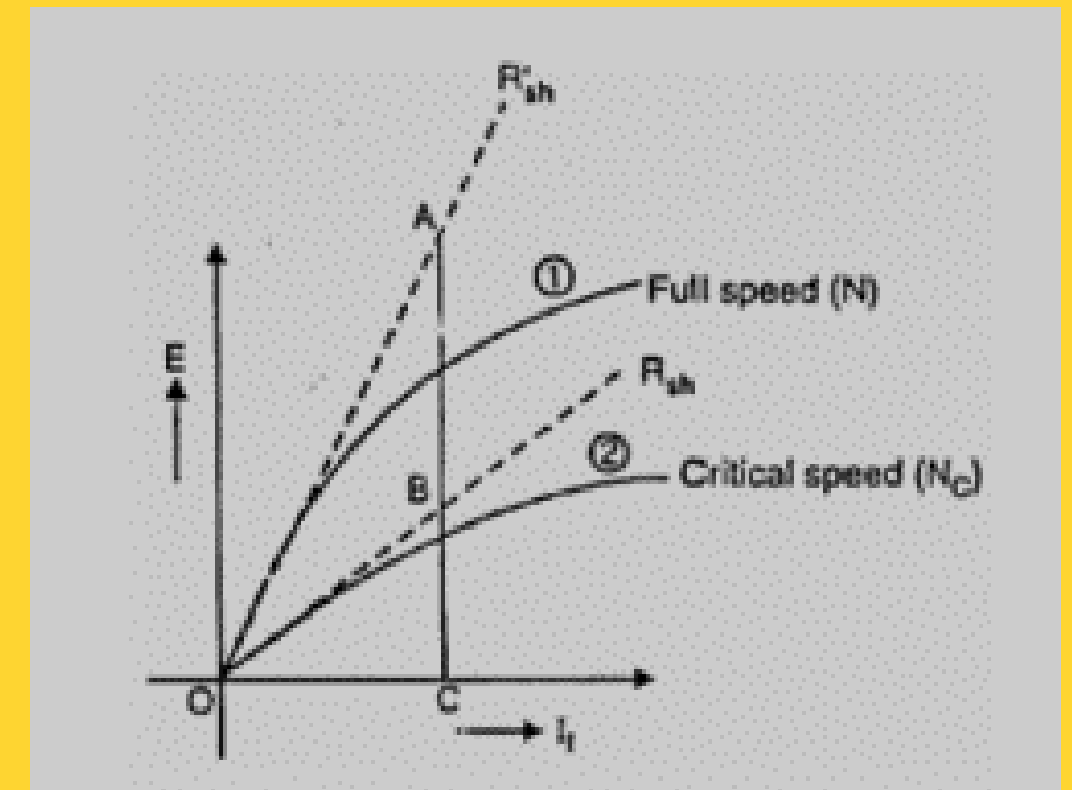



# Conditions for Voltage Build-Up of a Shunt Generator



The necessary conditions for voltage build-up in a shunt generator are:

- (i) There must be some residual magnetism in generator poles.
- (ii) The connections of the field winding should be such that the field current strengthens the residual magnetism.
- (iii) The resistance of the field circuit should be less than the critical resistance. In other words, the speed of the generator should be higher than the critical speed.





# Characteristics of Separately Excited D.C. Generator

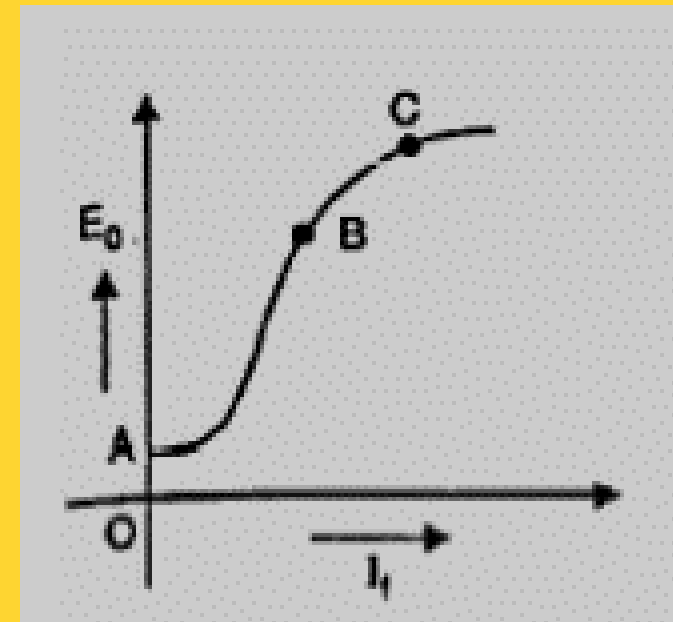
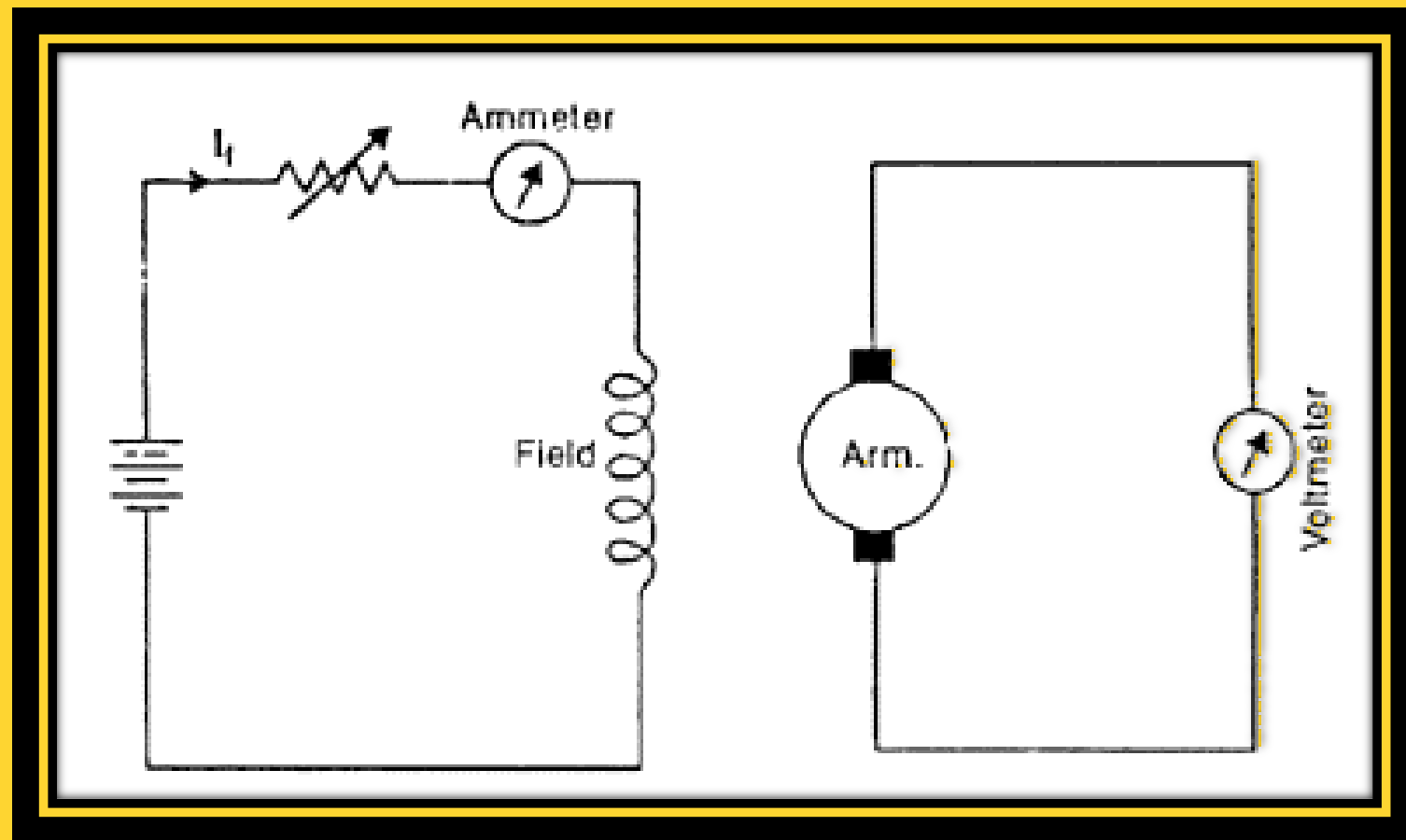

OCC

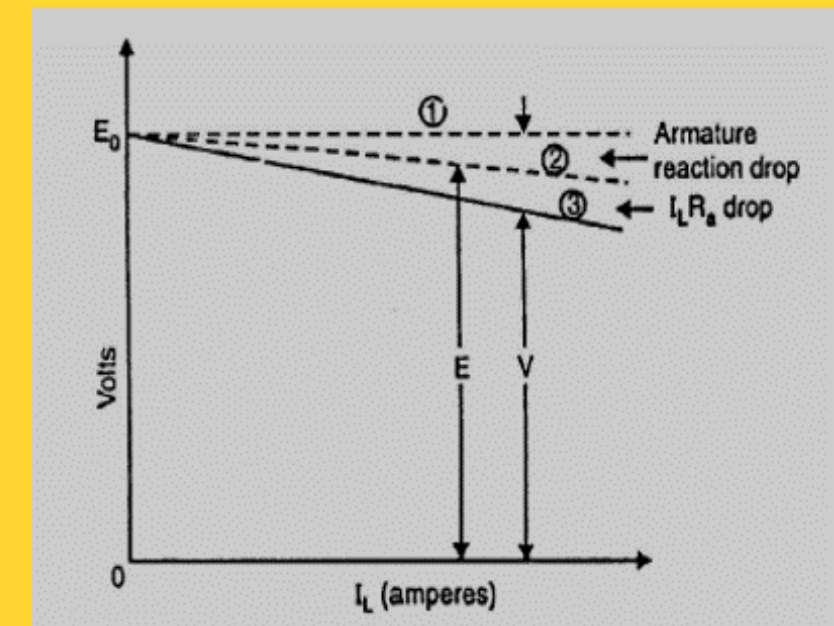

Internal & External



# Characteristics of Shunt Generator

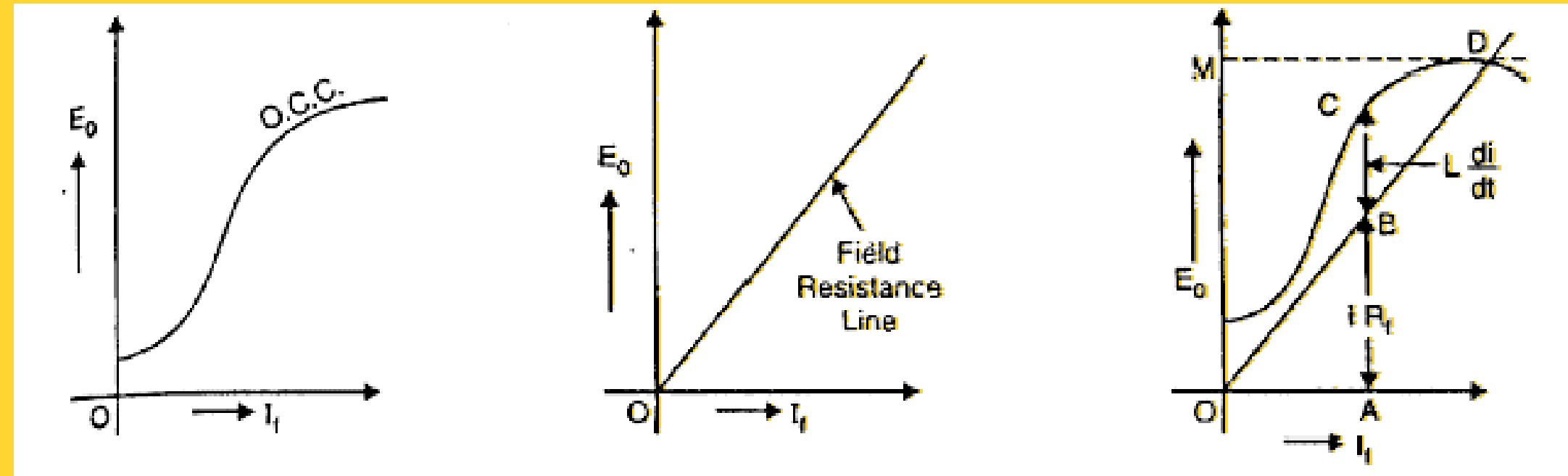
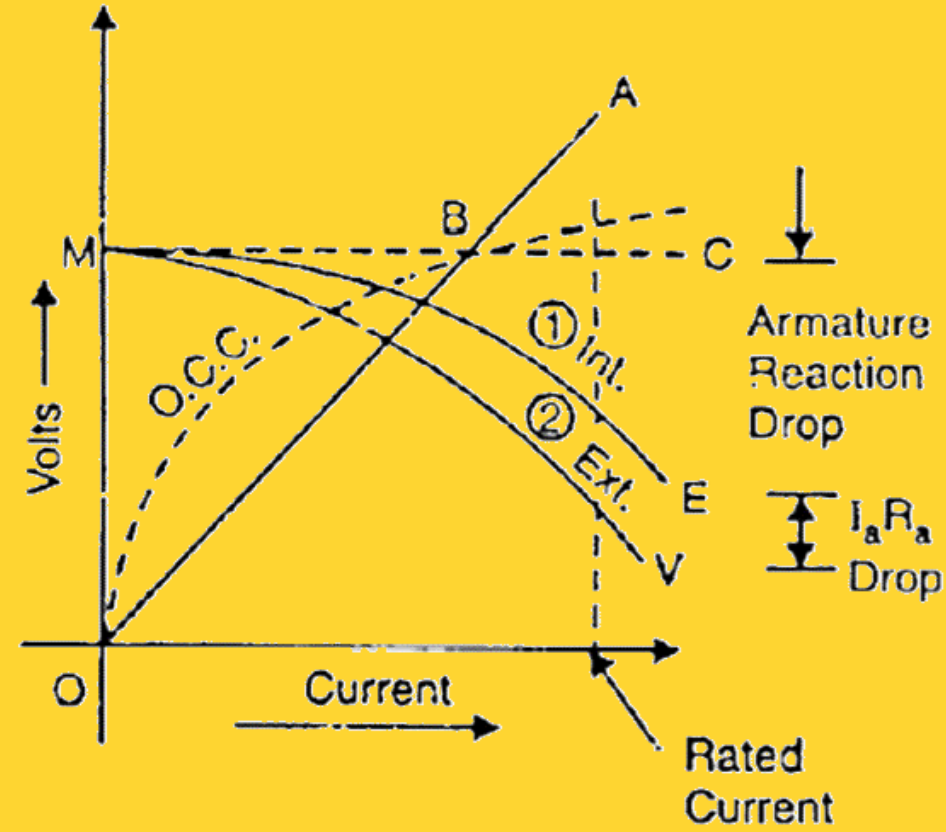
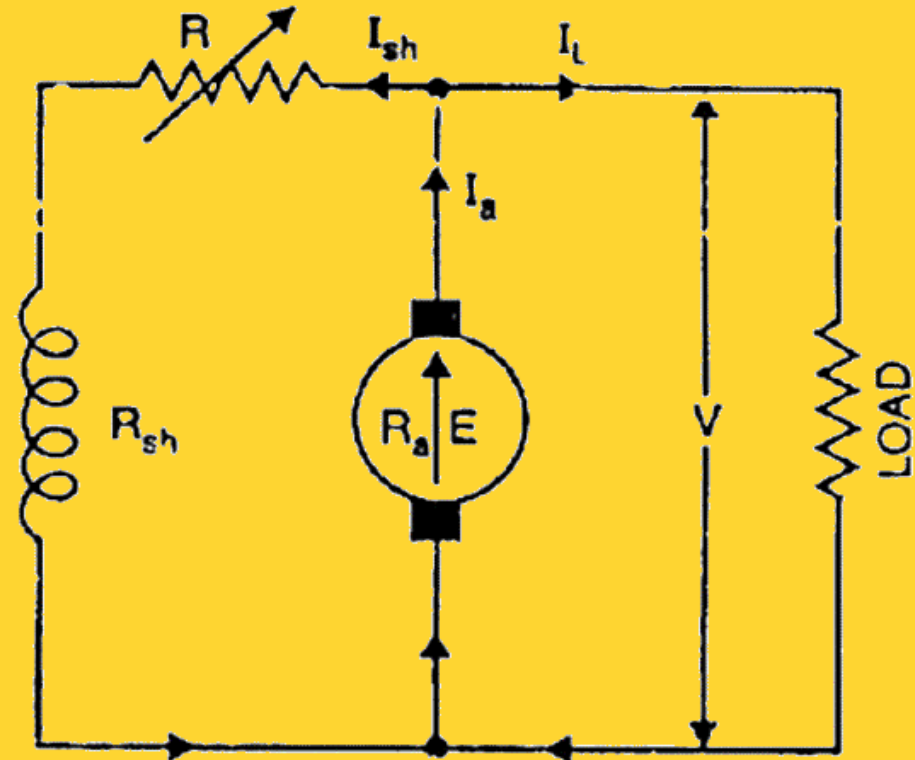



# Characteristics of Series Generator

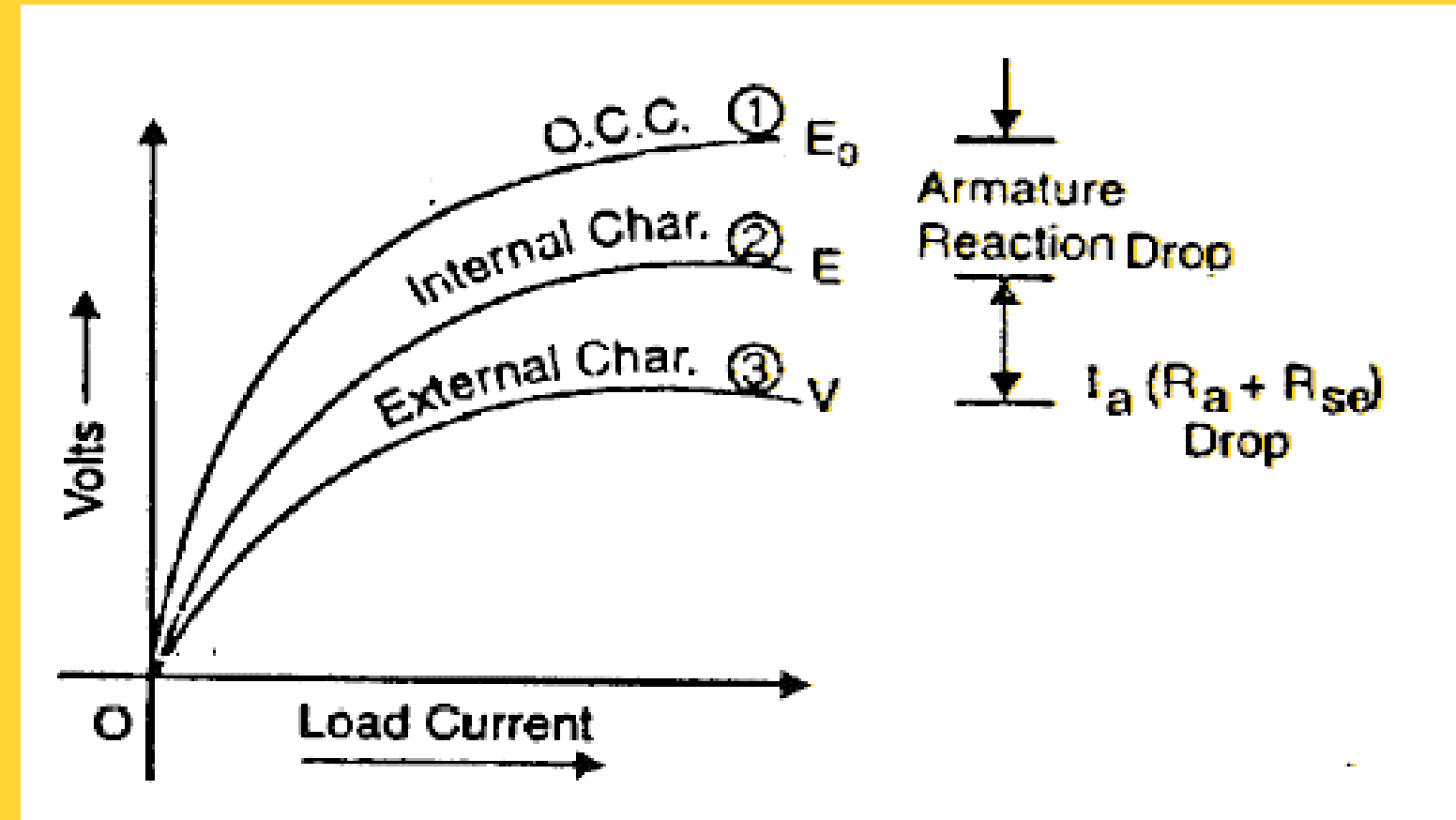
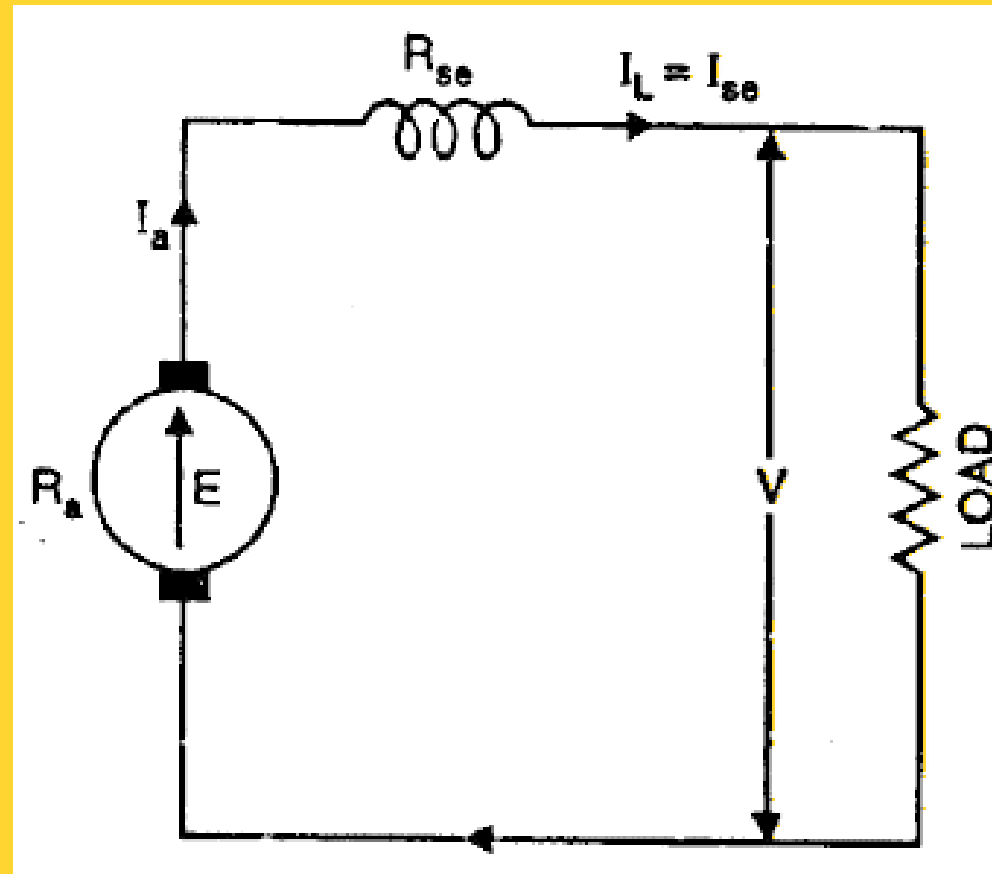



# Compound Generator Characteristics

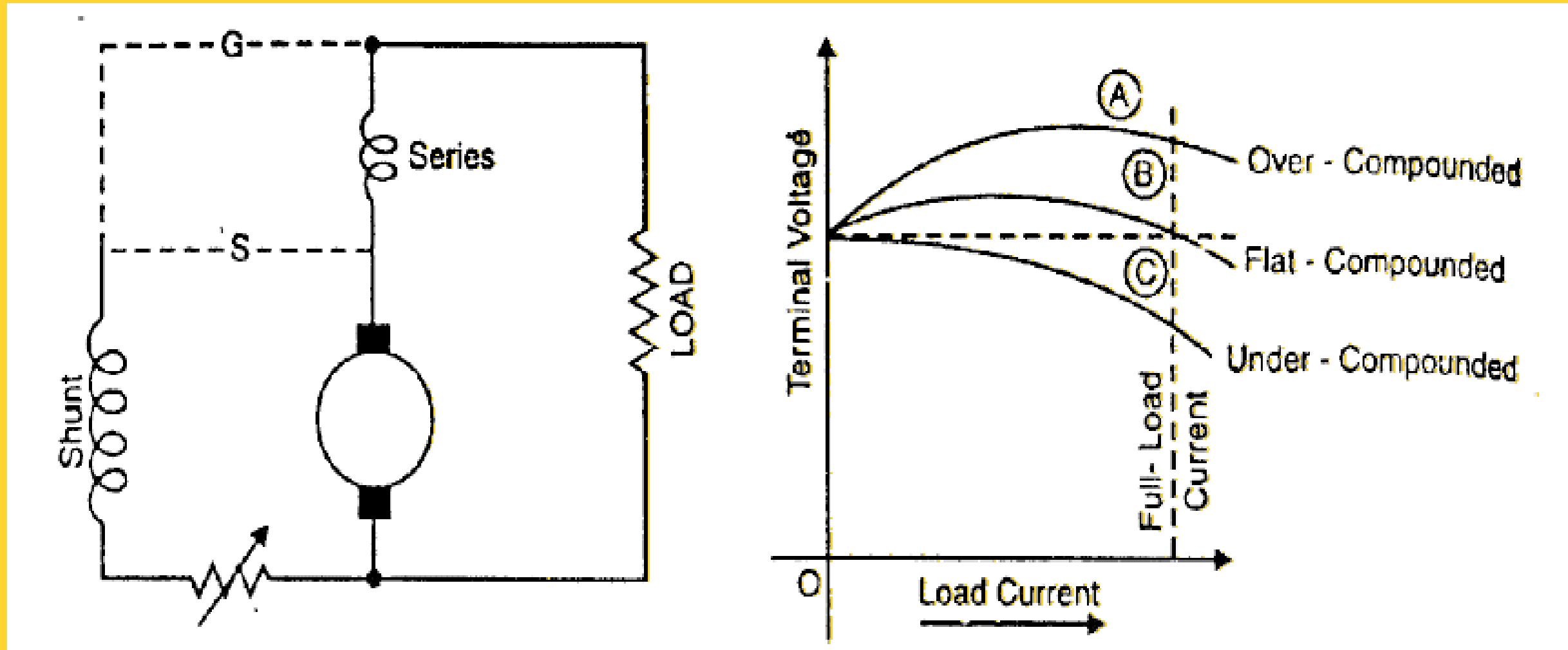



# Recall

Name the three most important characteristics in a D.C. generator

List the necessary conditions for voltage build-up in a shunt generator:

(i)

(ii)

(iii)



# Practical Implementation

In the Laboratory,  
Practically conduct experiment on DC  
generator set and obtain its  
characteristics

U could see the characteristics  
obtained as discussed in the class

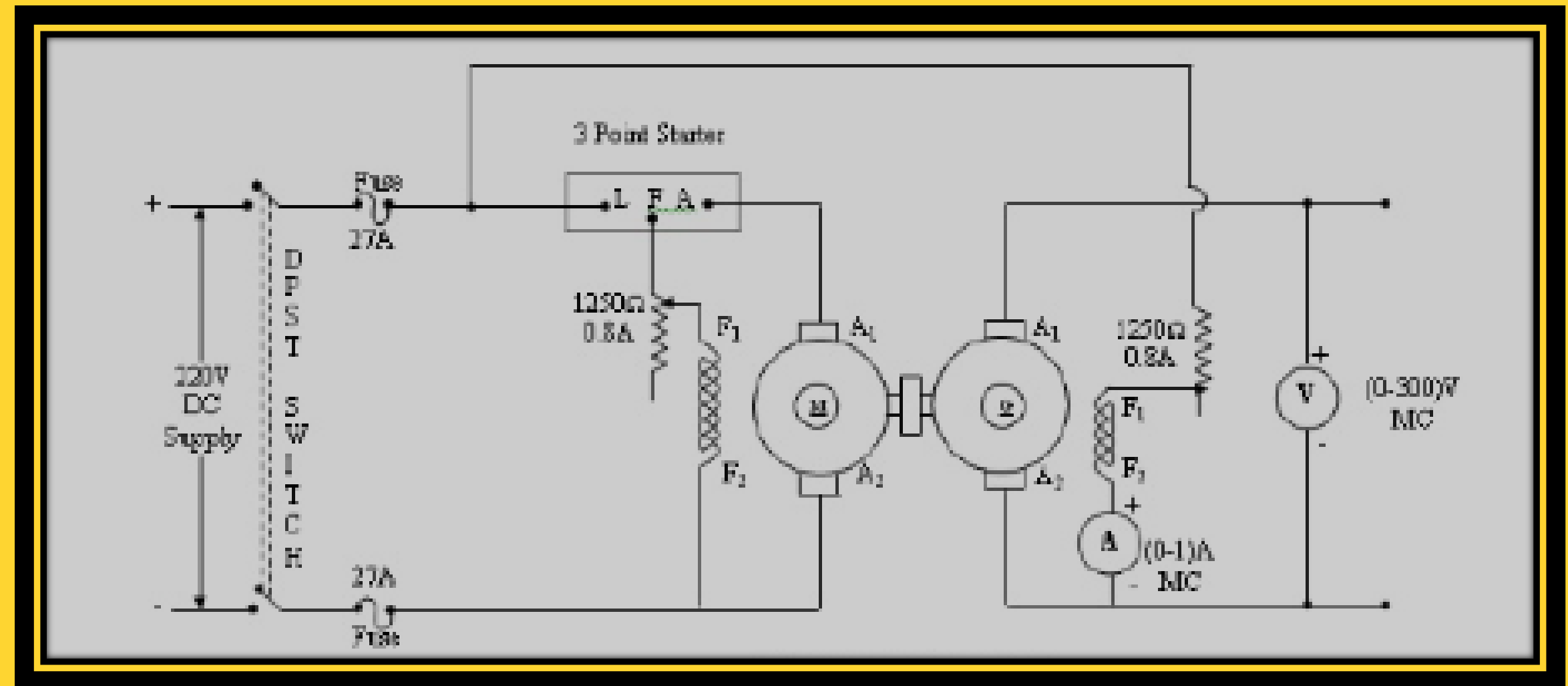



# THANK YOU